

LINHA SIMPLES CONTINUA AMARELA
COM TACHÕES A CADA 1,00m

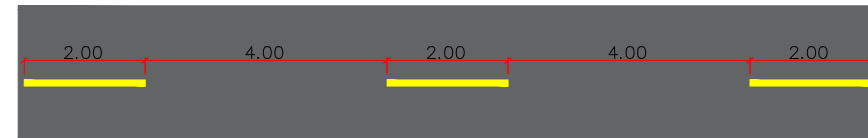

LINHA SIMPLES SECCIONADA AMARELA
CADÊNCIA (2X4X2)



PLACA DE SINALIZAÇÃO
INCLINAÇÃO DE 93° EM
RELAÇÃO AO SENTIDO
DE TRÁFEGO

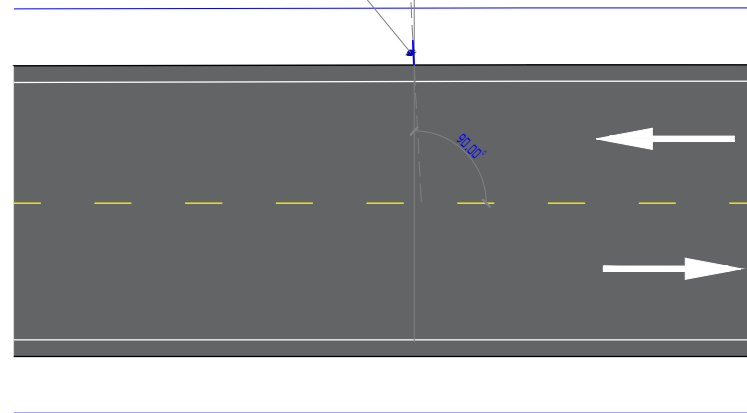

FAIXA DE PEDESTRE

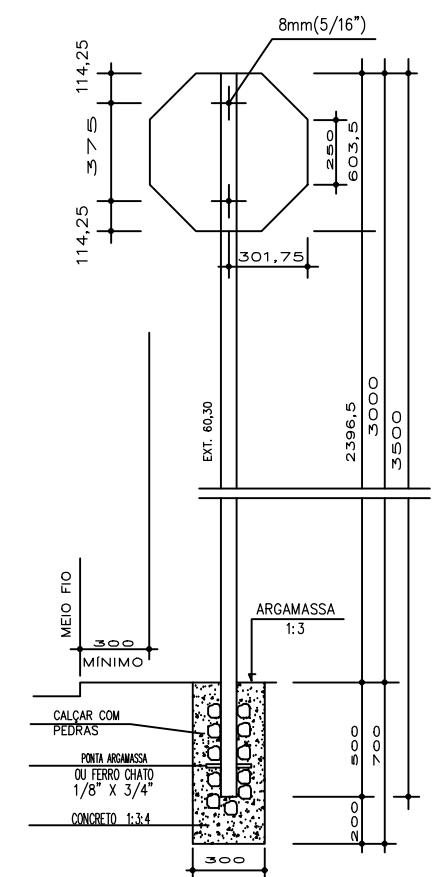
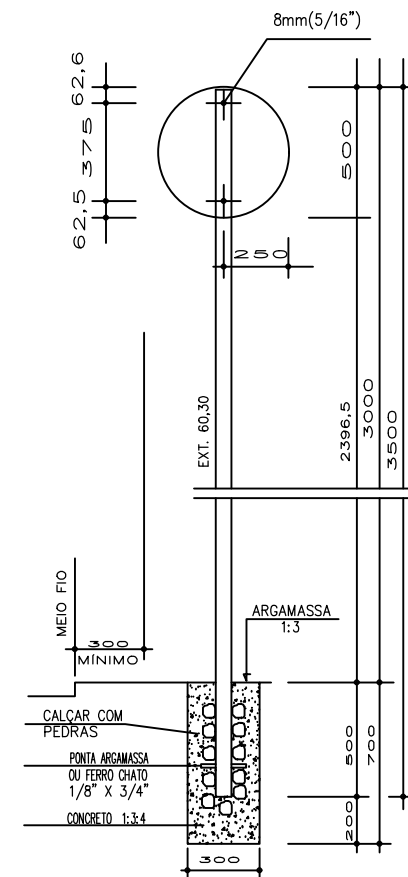
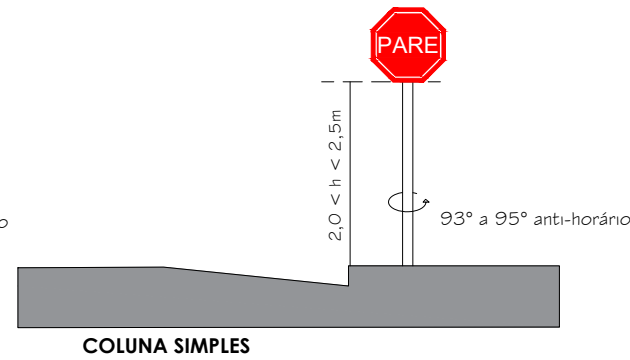
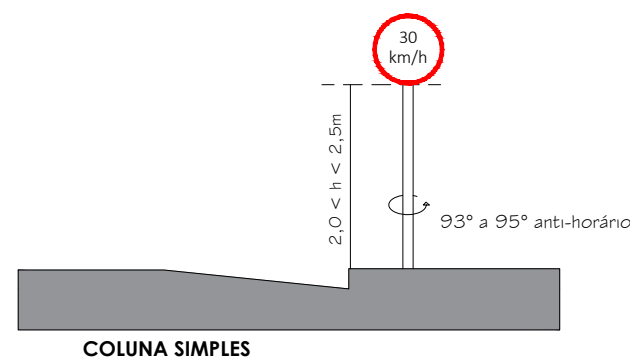
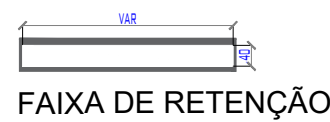
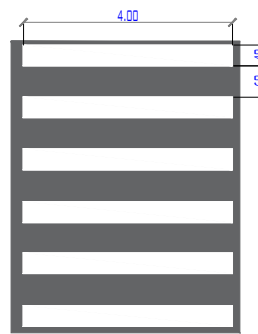

ANOTAÇÕES

DISCIPLINA: INFRAESTRUTURA URBANA

PROJ. GEOMÉTRICO SINALIZAÇÃO E DETALHES

RESP. TÉCNICO:

JEOVÁ MOTA VIEIRA
ENG. CIVIL

CREA: 0514093501-BA

DATA: 13/11/2023

Jeová Mota Vieira
Engenheiro Projetista
CREA nº 0514093501-BA
Port. nº 019/2021

PREFEITURA MUNICIPAL DE CÂNDIDO SALES
SECRETARIA MUNICIPAL DE ADMINISTRAÇÃO



EMPREENDIMENTO: RECUPERAÇÃO DE PAVIMENTO EM DIVERSAS RUAS DO MUNICÍPIO

LOCAL: SEDE DO MUNICÍPIO

PROJETO: URBANIZAÇÃO - SINALIZAÇÃO E DETALHES

ESC.: 1:500

MUN.: CANDIDO SALES-BA

PRANCHA:
F/A3

1/01